



SP SERIES

SPECIFICATIONS

FAMILY RANGE

Code	Power	Dimensions	Cut-out 
SP-9083C-10	10W	98*98*H85mm	85*85mm

PARAMETERS



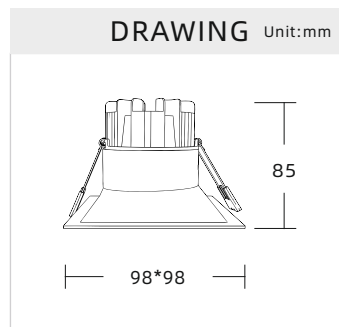

Efficacy	75lm/W
CRI	85
Adjustable	YES
Color Consistency	SDCM<3
Pf	0.5
Input Voltage	AC220-240V 50/60Hz
Operating Temp.	-20°C~60°C
Working Hours	50,000 Hrs

APPLICATION

- Modern Workspaces
- Institutions
- Small format Retail outlets
- Hotels
- High end Villa's



LED

COB	CCT
	 3000K  4000K  6000K

Finish



Material Description

Housing: Die-cast aluminum
 Reflector: Mirror finished aluminum
 Diffuser: PMMA Opal pc Lens

Beam Angle

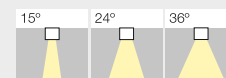

Dimming Options



Photometric

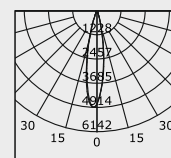

For detailed technical project cut sheet can be requested by our online portal at www.priorled.com

